

Article number: 51030355000010

Description: Vibration damper GS-M2  
70x60x2000-10, NR shore 57

## Measures

---

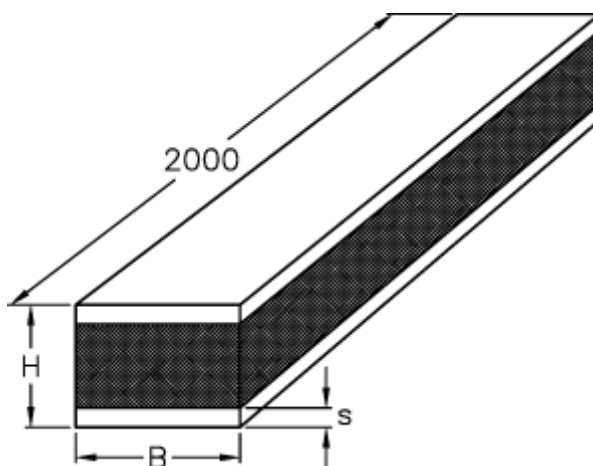

B = 70  
H = 60  
S = 10